

NOTICE D'INSTALLATION RECEVEUR DE DOUCHE

AVANT DE COMMENCER

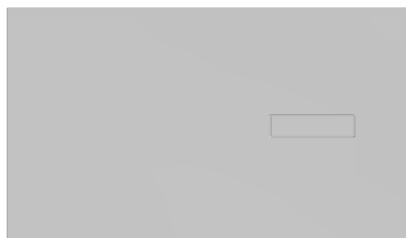
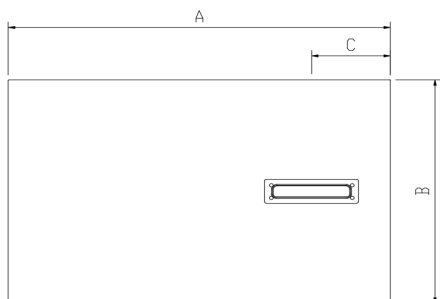

Taille	A(cm)	B(cm)	C(cm)
80100	100	80	24.75
80120	120	80	24.75
80140	140	80	34.75
80160	160	80	39.75
9090	90	90	24.75
90100	100	90	24.75
90120	120	90	24.75
90140	140	90	34.75
90160	160	90	39.75

- Le receveur de douche doit être installé sur une surface plane et nivelée, exempte de toute bosse.

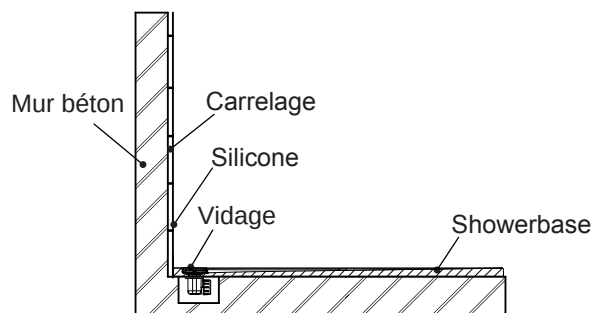

INSTALLATION

1. Préparez le receveur de douche et les outils.
Retirez le film protecteur autour de la zone du trou d'évacuation.

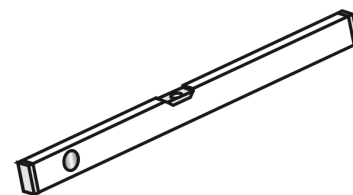
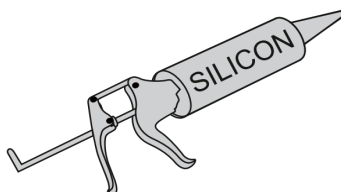
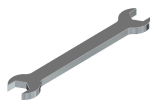

2. Installez la bonde sur le receveur.



OK

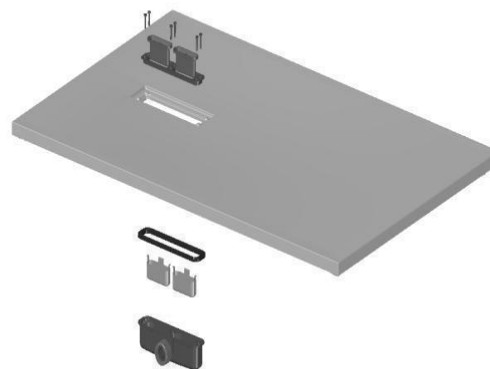
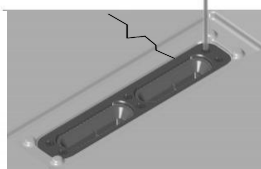
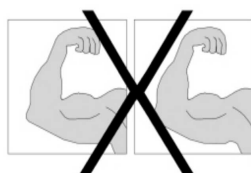
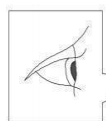

3. Assurez-vous que le système de vidage est correctement installé et ne présente aucune fuite.

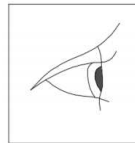
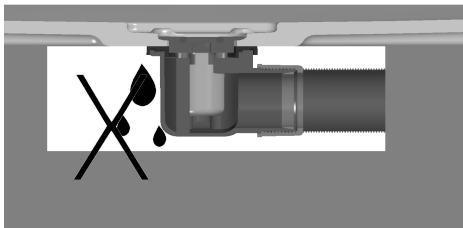
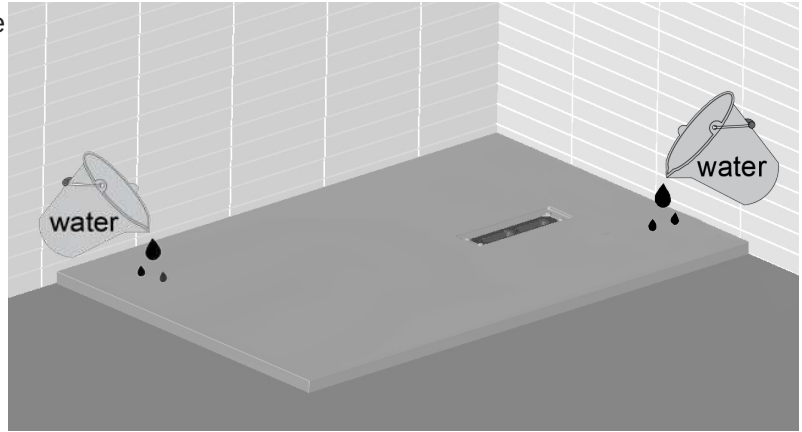

OK

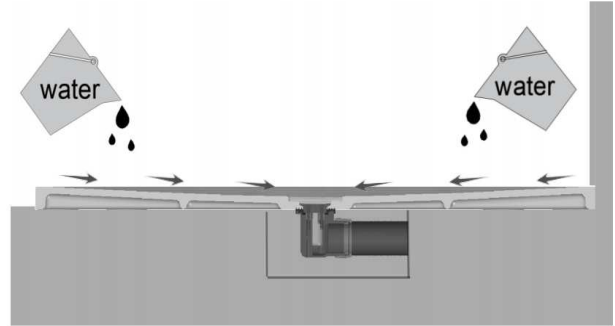

4. Assurez-vous que l'emplacement du receveur de douche est ferme, de niveau et propre.

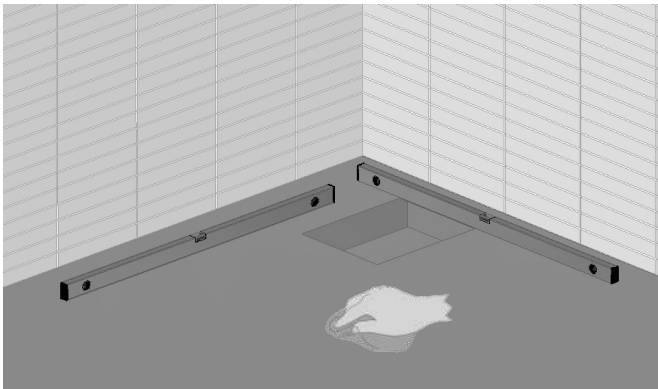

5. Installez le receveur de douche sur une couche de 15 mm de mélange ciment-sable. Veuillez noter que si vous utilisez des adhésifs à base d'eau, il est recommandé d'appliquer un primer approprié sur la base du receveur de douche avant l'installation pour améliorer l'adhérence.

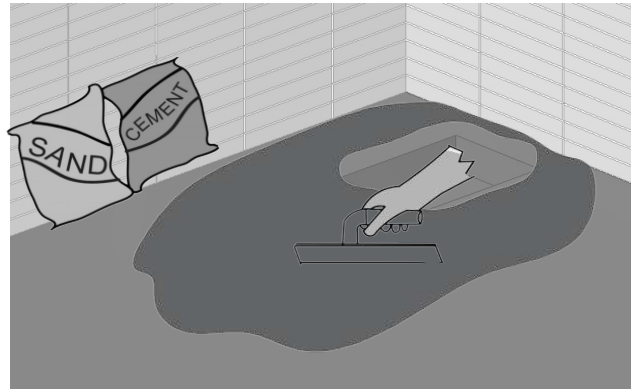

6. Veuillez vous assurer que le receveur de douche est de niveau.

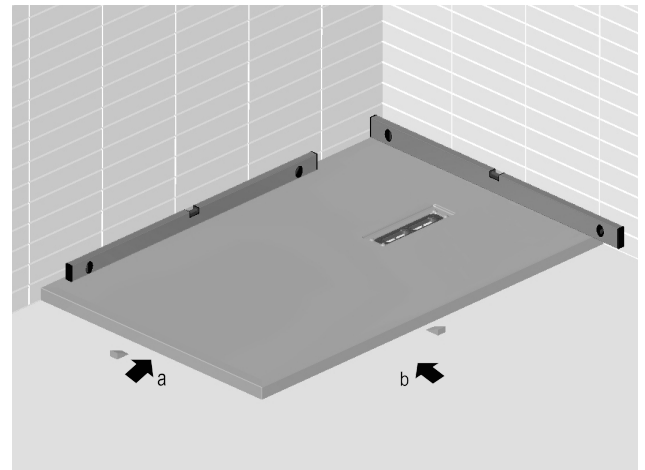
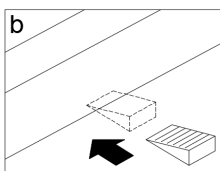
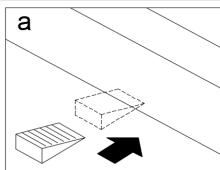
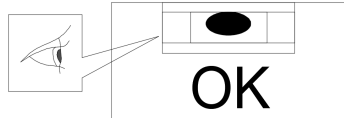

7. Sceller les joints entre le receveur et le mur, et le sol, avec un mastic silicone et laisser sécher pendant 24 heures.

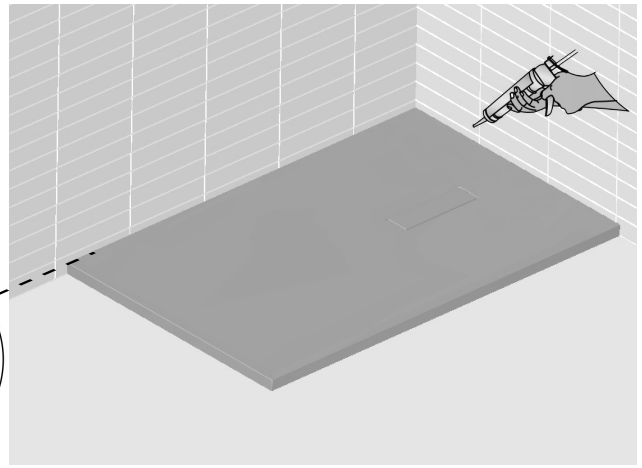
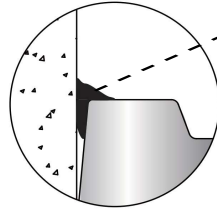

INSTALLATION DES PIEDS

1. Nettoyez la surface des pieds avec de l'alcool.
Nettoyez l'emplacement à l'arrière du plateau où les pieds doivent être installés.

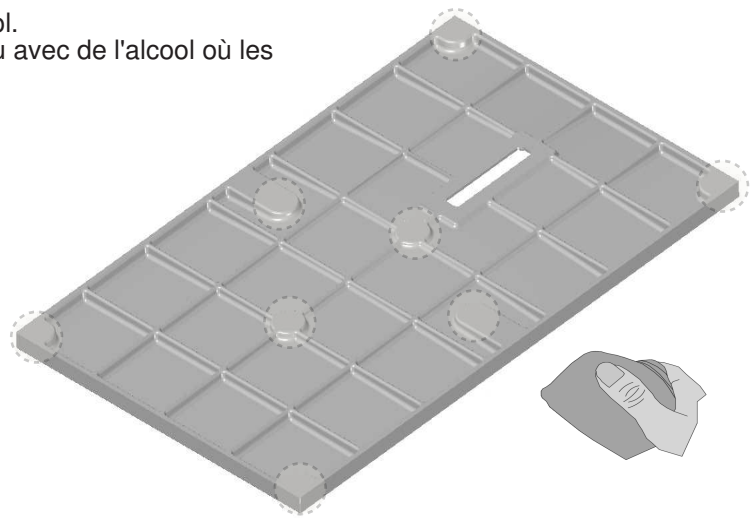
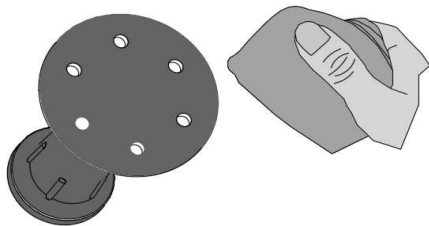

2. Installez les pieds.

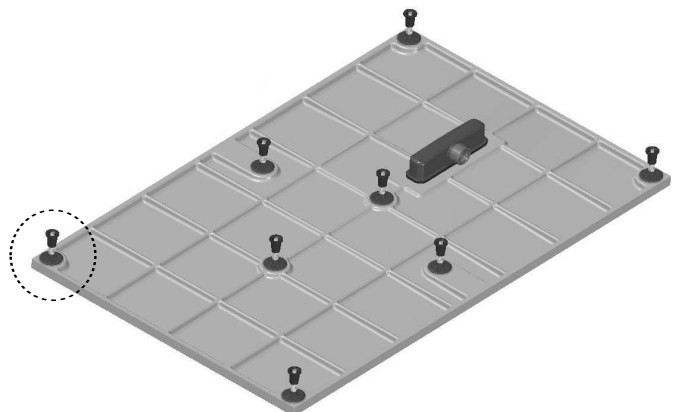
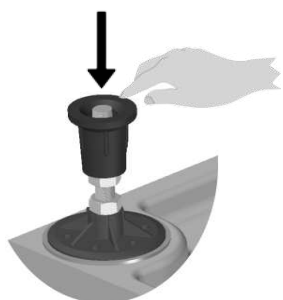

3. Ajustez les pieds avec le niveau à bulle.

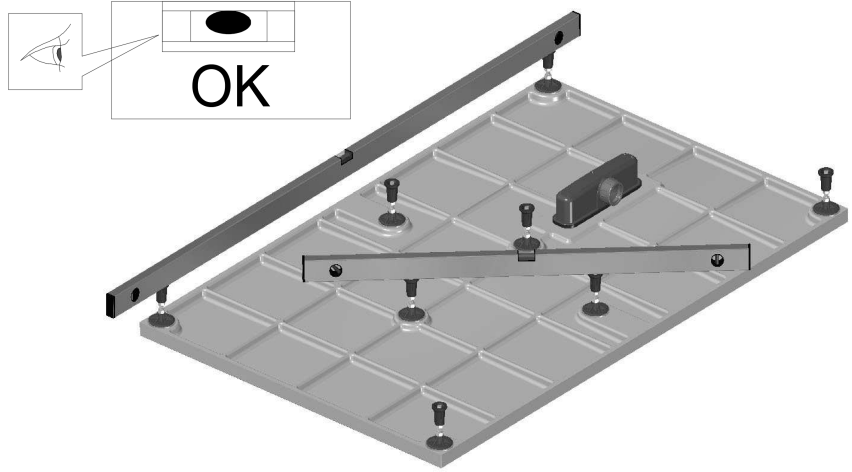

4. Veuillez vous assurer que le receveur de douche est de niveau.

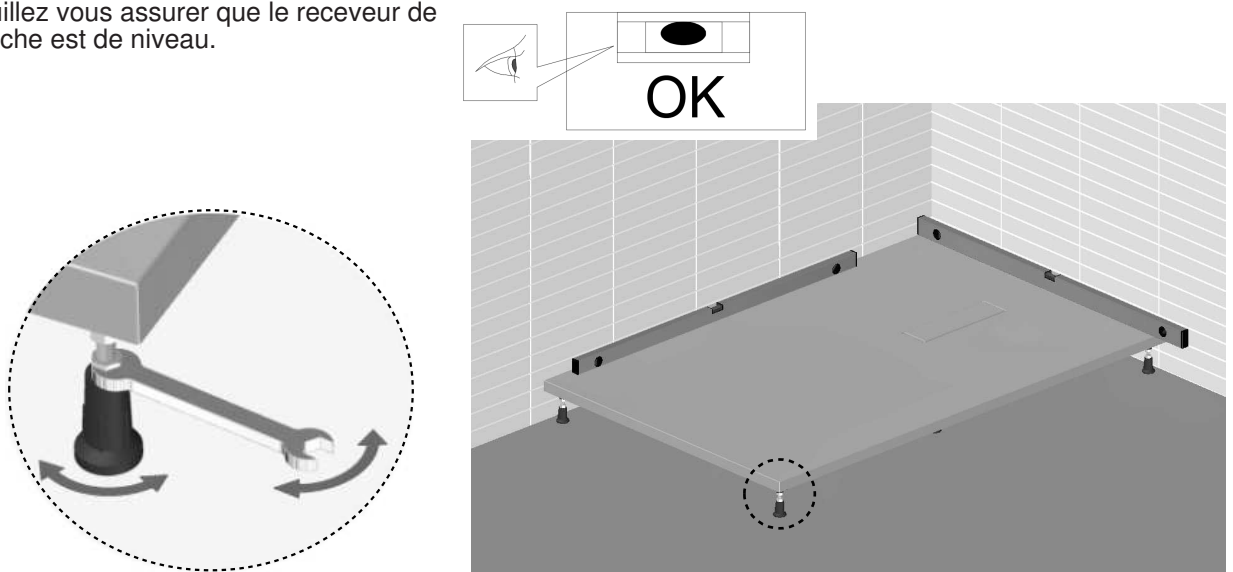

5. Sceller les joints entre le receveur et le mur, et le sol, avec un mastic silicone et laisser sécher pendant 24 heures.

